

Branddør EI30

Datablad



Beskrivelse

Døren er beregnet til indvendig brug. Temperaturforskellen mellem rum op til 5 grader.

Ydelsesevne

Brandklassificering:	EI ₂ 30-C
Lydisolering:	-
Isoleringsevne:	-
Røggas test:	-
Indbrudstest:	-



Tekniske specifikationer

Størrelse:	Enkeltdøre M7-10 x 21. Max M12 x 22 Tilvalg: Kan produceres på specialmål.
Farve:	Standard Hvid 0502-Y, glans 25. Tilvalg: Andre farver kan tilvælges
Dørblad:	Glat 40 mm. Tilvalg: Pyntelister og påsatte fyldninger.
Glas:	-
Karm:	Softwood 42 x 100/121 mm. Tilvalg: Karmdybde fra 92 - 220 mm.
Bundstykke:	Standard 15/22 mm falset lakeret eg. Tilvalg: Se side 2
Tætningsliste:	-
Låsekasse:	Standard 565 falle/rigel Tilvalg: Venligst forespørg
Hængsler:	3 x 3248-110
Slutblik:	1887-2
Tilbehør:	Dørspion, sparkeplade mm. Venligst forespørg for øvrige



Branddør EI30

Datablad

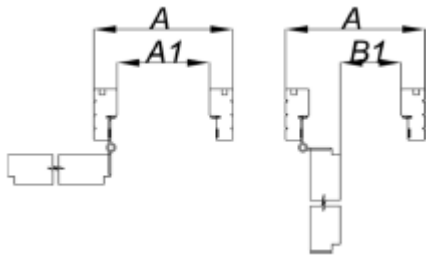

Friåbning:

Module	A (mm)	A1 (mm)	B (mm)	B1 (mm)	3248-110
M9x21	890	806	825	763	
M10x21	990	906	925	863	

Bundstykker:

Standard:

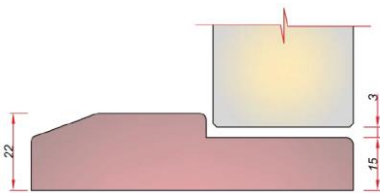

Tilvalg:

Til enkeltjør:

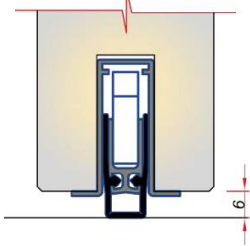

Til enkeltjør. Lydklassificering bortfalder ved brug uden bundstykke.

Ikke brandbart gulv:

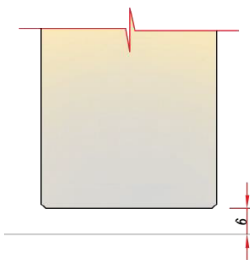

Brandbart gulv:

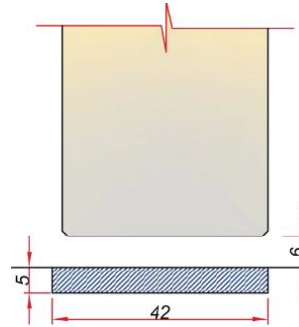

Låsekasse placering:

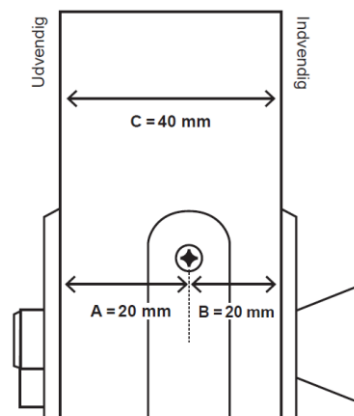

Vandret snit:

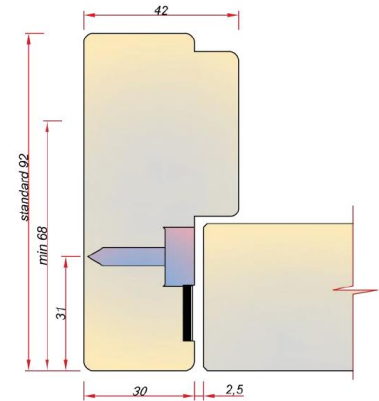

Lodret snit:

